

526

18TH ST.

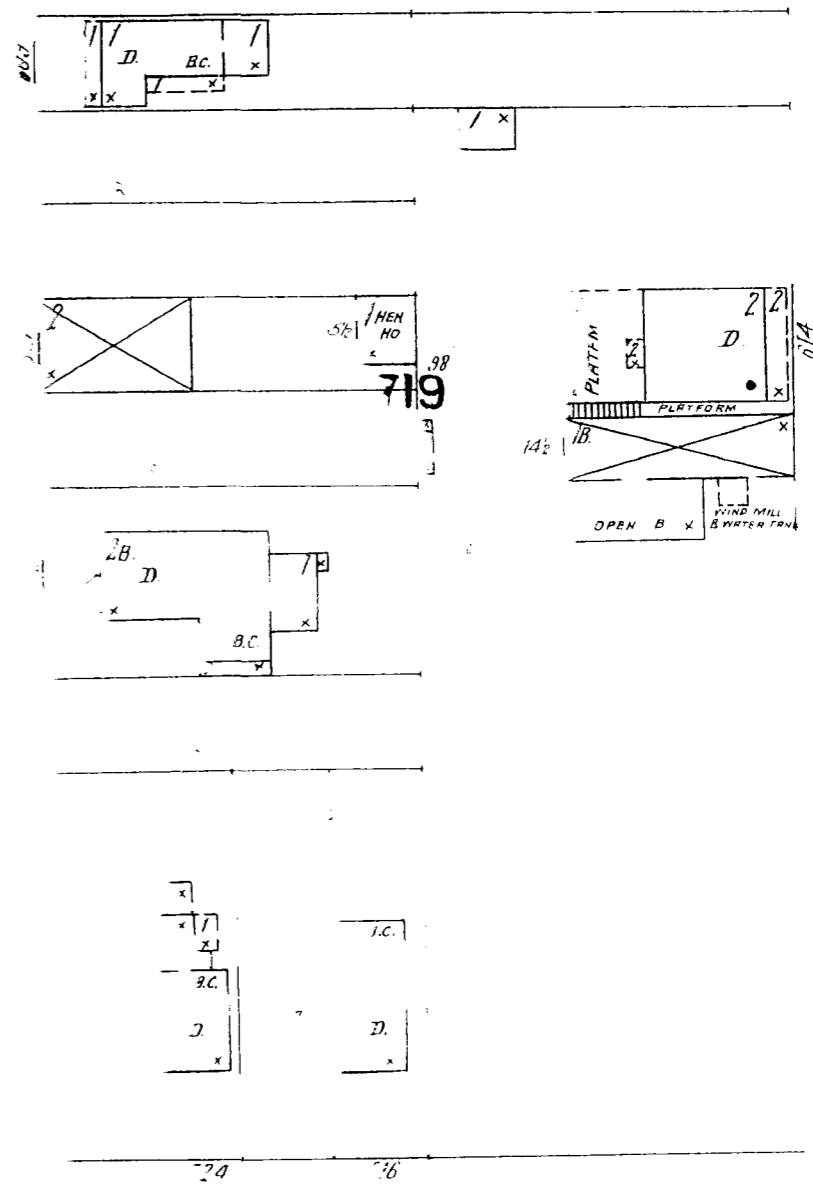
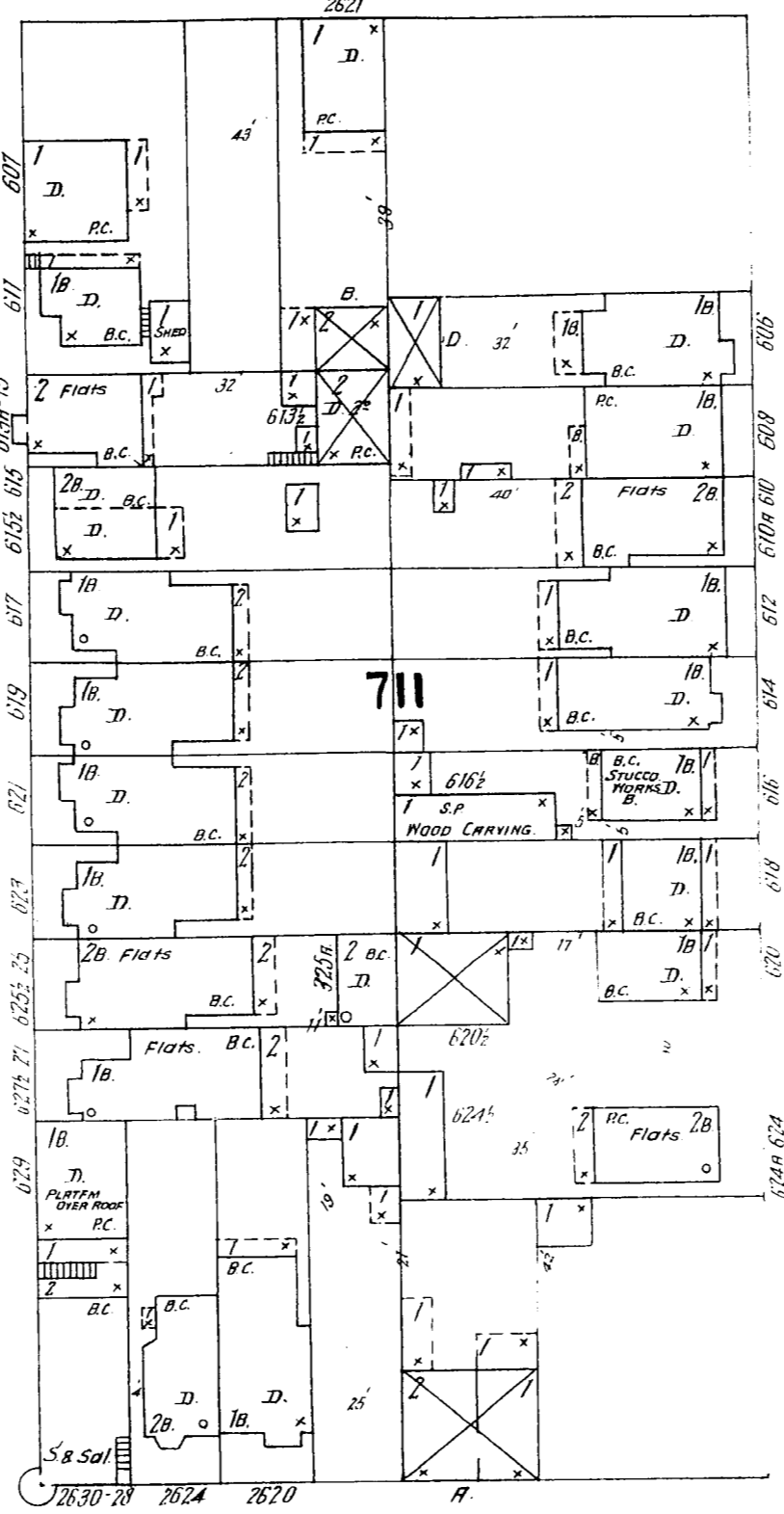
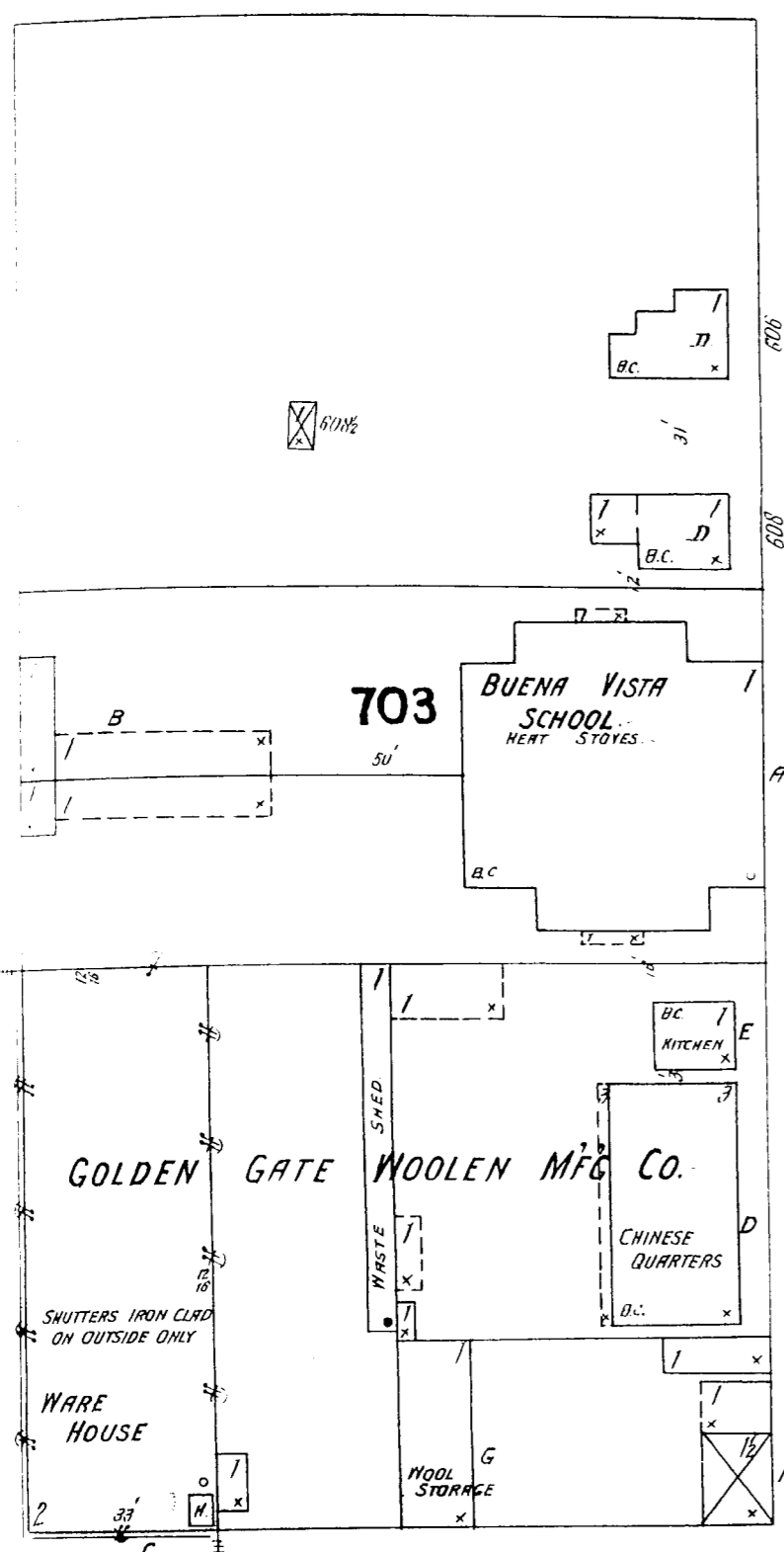
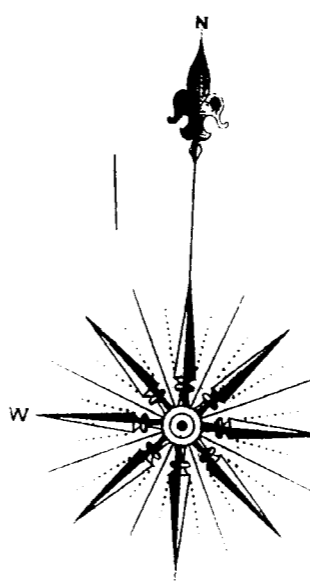

535

19TH ST.

6 ft wide

523

GOLDEN GATE WOOLEN MFG CO'S MILLS.
NIGHT AND SUNDAY WATCHMAN - CLOCK 9 STATIONS - HOURLY ROUNDS -
POWER STEAM - FUEL COAL - LIGHTS GAS - 2 CHEMICAL FIRE EXTINGUISHERS -
4 2 1/2 IN. BOARDS AND HUMBERGOLS HYDRANTS RES. SHOWING
MINI WATER SUPPLY FROM WELL INTO 25000 GALLON TANK
FIRE HYDRANT CONNECTIONS WITH EITHER TANK OR SPRING VALLEY

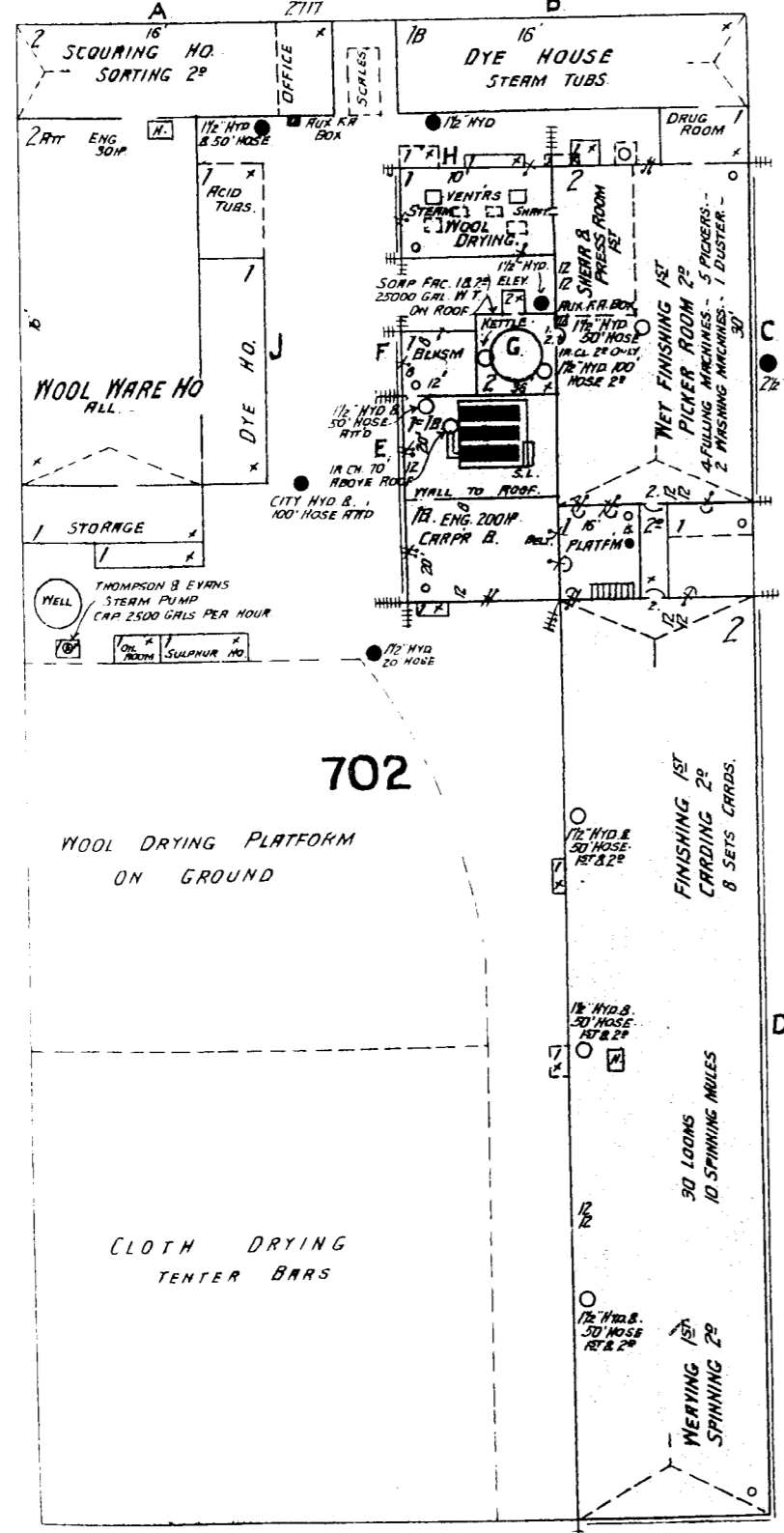

YORK

HAMPSHIRE

YORKING

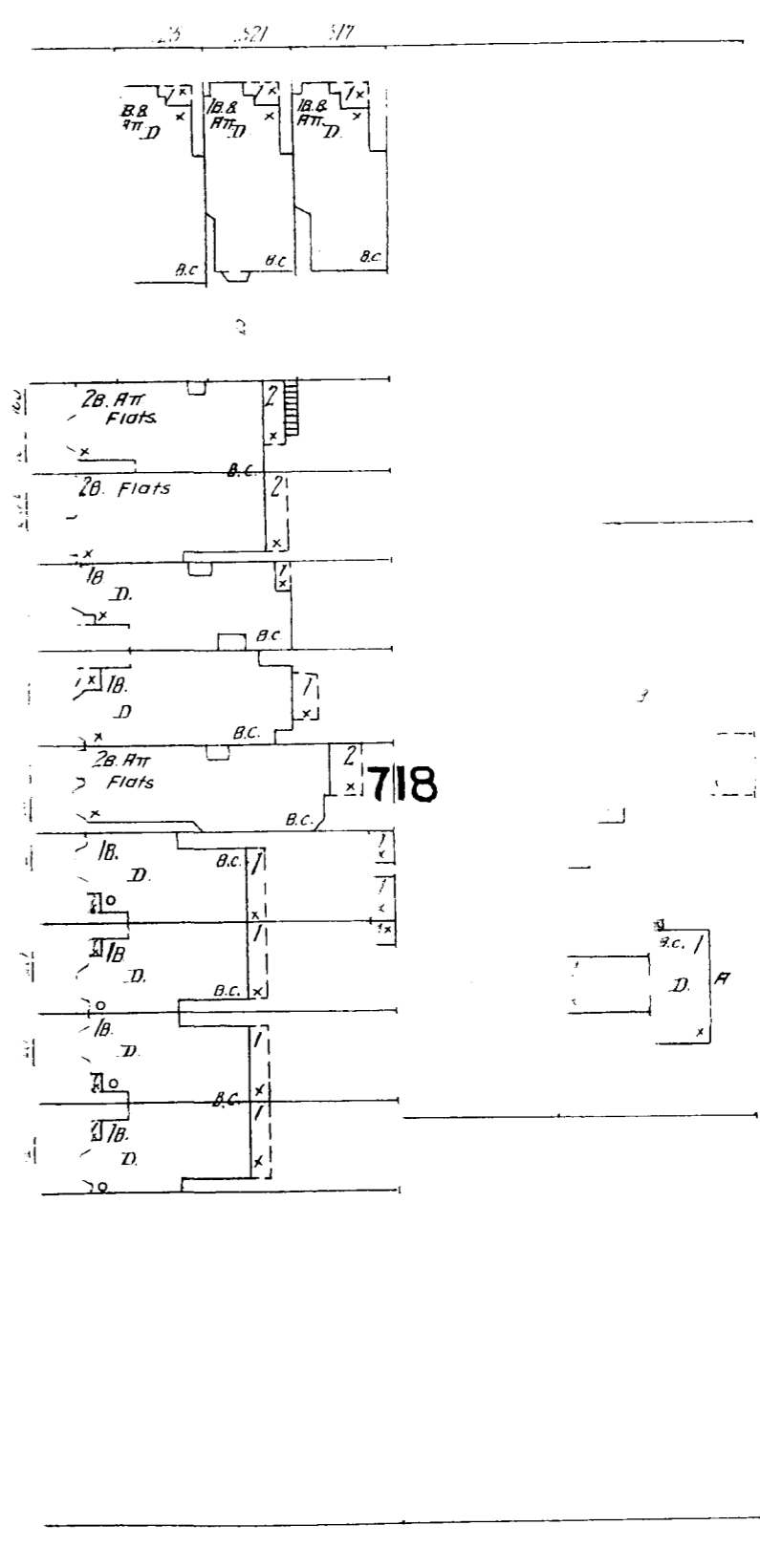
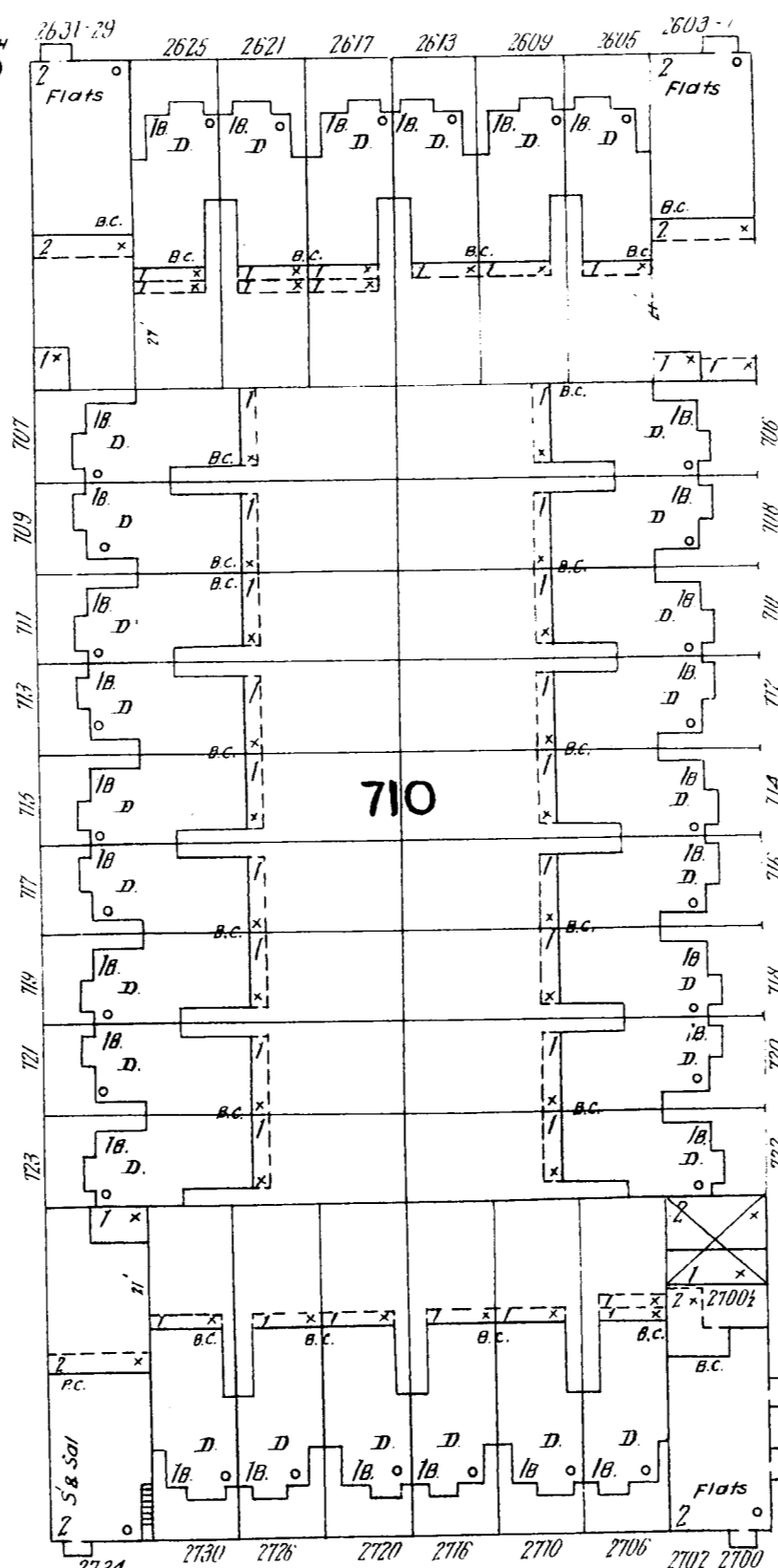

547

20TH ST.

522

